

ISOLDE 500/500 + brushing station

Continuous through feed grinder equipped with
1 vertical spindle, 1 horizontal spindle and 1
planetary brushing station

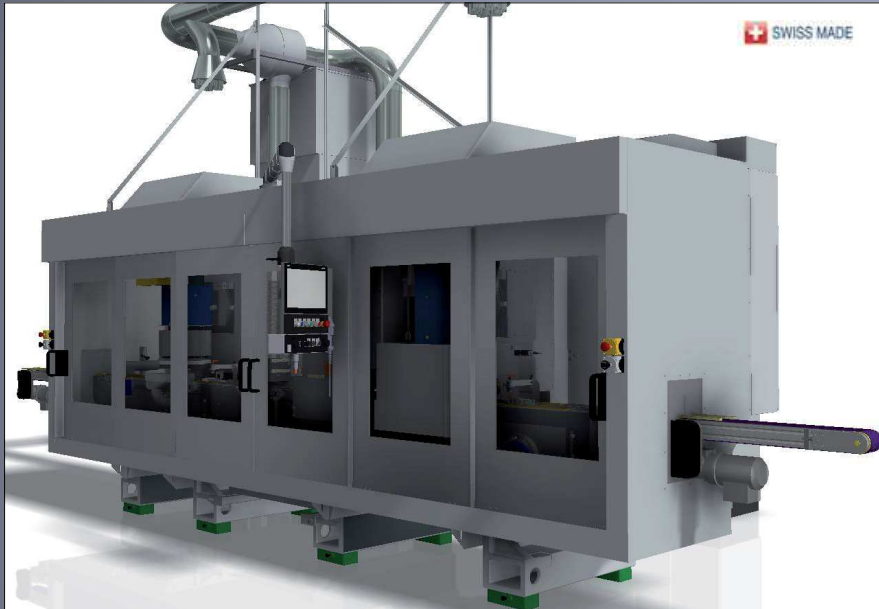

Performances

- Resolution 0.001 mm
- High performance spindles, direct drive
- Modular rigid frame of grey cast iron combined with prestressed concrete
- Measurement and automatic servo
- Additional brushing module
- Automatic, semi-automatic or manual loading

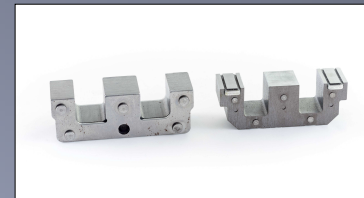

Dressing

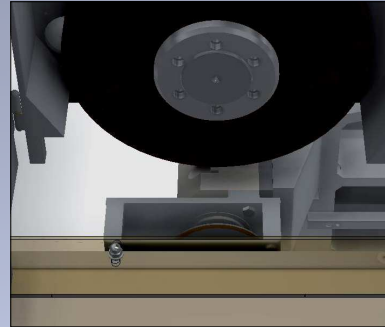

Measurement

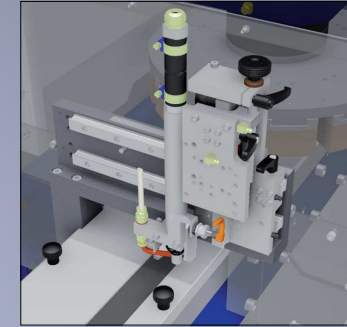

Manual

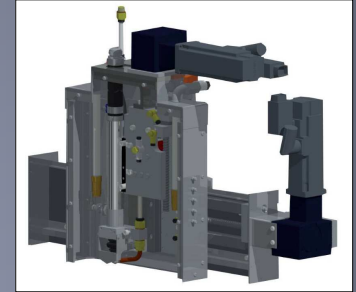

Automatic

Spindle

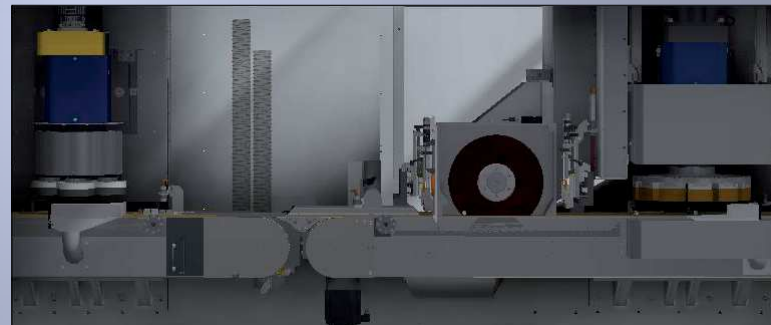

Grinding direction from right to left

Demagnetizer

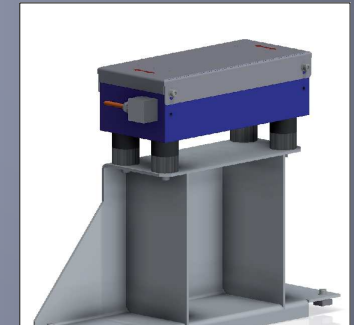

LINEAR ABRASIVE Engineering S.A.
Bellevue 5
2074 Marin / Switzerland
Phone: +41 (0)32 753 36 33 Fax: +41 (0)32 753 21 69
E-mail: commercial.center@linear.ch



LINEAR ABRASIVE

Technical specifications

Number of spindles	3	Abrasive tools	CBN/diamond/Al2O3
Spindle (mm)	ø200x500	Grinding wheel (mm)	ø500 / ø400
Z-axis infeed (mm)	120	Infeed (mm/min)	0 - 6000
Direct spindle drive (rpm)	0 - 4500	Electrical control	Siemens S7/1500/TIA
Power (kW)	28, 11, 15	Total weight (t)	8 - 10
Width of machinable parts max. (mm)	150	Stock removal max. (mm)	0.01 - 0.15
Height of machinable parts max. (mm)	80	Resolution (mm)	0.001

Technology 3VHB:

Continuous through feed surface and profile grinder, equipped with 1 vertical spindle, 1 horizontal spindle and 1 planetary brushing station

Combined operations

Highly productive method for continuous through feed machining of surfaces and profiles, using AL2O3 cup, diamond and CBN wheel. Transported by a highly resistant composite belt, held by magnetic attraction (by mask or template for parts of non-magnetic material) the parts are guided between rails and pass beneath the grinding wheel. Controlled process and part program provide optimum performance.

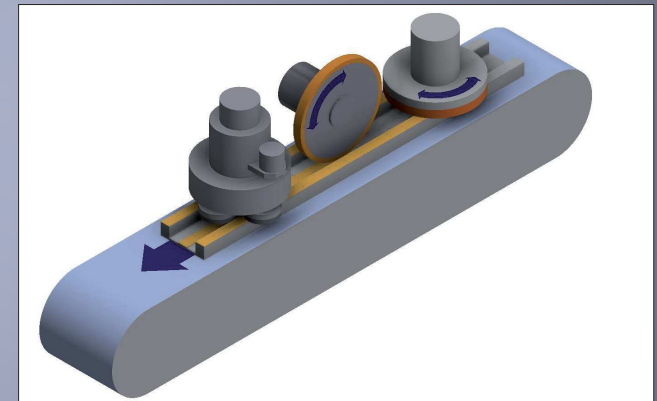

LINEAR ABRASIVE Engineering S.A.

Bellevue 5

2074 Marin / Switzerland

Phone: +41 (0)32 753 36 33 Fax: +41 (0)32 753 21 69

E-mail: commercial.center@linear.ch



LINEAR ABRASIVE